



Use And Care

G U I D E

A stylized black and white illustration of two hands holding a document. The hands are rendered with thick black outlines and white highlights. The document is held between the fingers, and its edges are visible. The background is a simple white space within a rounded rectangular frame.

A Note To You	2
Understanding Safety	3
Knowing Your Dryer's Features	5
Operating Your Dryer	6
Using Your Options/Features	13
Caring For Your Dryer	15
Laundry Tips	20
If You Need Assistance Or Service	26
Warranty	28

1-800-253-1301
Call us with questions or comments.

ELECTRONIC GAS AND ELECTRIC DRYERS

A NOTE TO YOU

A Note To You

Thank you for buying a Whirlpool® appliance.

You have purchased a quality, *world-class* home appliance. Years of engineering experience have gone into its manufacturing. To ensure many years of trouble-free operation, we have developed this Use and Care Guide. It is full of valuable information on how to operate and maintain your appliance properly and safely. Please read it carefully. Also, please complete and mail the Ownership Registration Card provided with your appliance. This will help us notify you about any new information on your appliance.

Your safety is important to us.

This guide contains safety statements under warning symbols. Please pay special attention to these symbols and follow any instructions given. Here is an example of the use of the symbol.

<p>⚠ WARNING</p> <p>This symbol will help alert you to such dangers as personal injury, burns, fire and electrical shock.</p>
--

Our Consumer Assistance Center number, 1-800-253-1301, is toll-free 24 hours a day.

If you have a question concerning your appliance's operation, or if you need service, first see "If You Need Assistance Or Service" on page 26. If you need further help, call us. When calling, you will need to know your appliance's complete model number and serial number. You can find this information on the model and serial number label (see diagram on page 5). For your convenience, we have included a handy place below for you to record these numbers, the purchase date from the sales slip and your dealer's name and telephone number. Keep this book and the sales slip together in a safe place for future reference.

Model Number _____

Dealer Name _____

Serial Number _____

Dealer Phone _____

Purchase Date _____

Understanding Safety

⚠ WARNING

For your safety, the information in this manual must be followed to minimize the risk of fire or explosion or to prevent property damage, personal injury or loss of life.

–Do not store or use gasoline or other flammable vapors and liquids in the vicinity of this or any other appliance.

–WHAT TO DO IF YOU SMELL GAS:

- Do not try to light any appliance.
- Do not touch any electrical switch; do not use any phone in your building.
- Clear the room, building or area of all occupants.
- Immediately call your gas supplier from a neighbor's phone. Follow the gas supplier's instructions.
- If you cannot reach your gas supplier, call the fire department.

Installation and service must be performed by a qualified installer, service agency or the gas supplier.

IMPORTANT SAFETY INSTRUCTIONS

⚠ WARNING

To reduce the risk of fire, electrical shock, or injury to persons when using your dryer, follow basic precautions, including the following:

- Read all instructions before using your dryer.
- Do not machine wash or machine dry items cleaned, washed, soaked in, or spotted with wax, paint, gasoline, oil, dry cleaning solvents, and other flammable fluids. The fumes can create a fire hazard or explosion. Always hand wash and line dry items containing these materials.
- Do not allow children to operate, play with or crawl inside your dryer. Supervise children when your dryer is used near children.
- Do not reach into a dryer if the drum is moving.
- When removing from service or discarding a dryer, always remove the door to prevent accidental entrapment.
- Do not dry rubber, rubber-like, and heat-sensitive materials with heat.
- Install and/or store dryer where it will not be exposed to the weather.
- Do not tamper with the controls.
- You are responsible for making sure that your dryer is installed, repaired and has parts replaced by a qualified person.
- Use only fabric softeners specifically labeled as not being harmful to the dryer.
- Do not allow lint to build up inside the dryer or exhaust system. Cleaning should be done periodically by a qualified person.
- Clean lint screen before or after each load.
- Do not let dust, lint, paper, rags, chemicals, etc. pile up around or under the dryer.
- Dryer must be electrically grounded. See the Installation Instructions.

Understanding your responsibilities

- Never operate the dryer if:
 - it is not working right (i.e. noisy, too hot).
 - it is damaged.
 - parts are missing.
 - all panels are not in place.
 - the lint screen is loose, damaged or missing.
 - Unplug the power supply cord or turn off electrical power before attempting to service your dryer. Also, shut off gas valve if you have a gas dryer.
 - Do not wash or dry items that are soiled with vegetable or cooking oil. These items may contain some oil after laundering. Due to the remaining oil, the fabric may smoke or catch fire by itself.
 - Store flammable solvents or fluids away from your dryer.
 - Dry cleaning solvents or fluids should never be put directly into your dryer.
 - Be sure that your dryer:
 - is properly installed and leveled on a floor that can support the weight in a well-ventilated room.*
 - is connected to the proper outlet and electrical supply.*
 - is properly connected to fuel and exhaust systems (gas dryers must be vented outdoors).*
 - is not installed against draperies or curtains, or on carpet.*
 - is located in an area where the temperature is above 45°F (7°C).
 - is properly maintained.
 - is used only for jobs normally expected of home clothes dryers.
 - is not used by anyone unable to operate it properly.
- *See the Installation Instructions for complete information.

– SAVE THESE INSTRUCTIONS –

Knowing Your Dryer's Features

The parts and features of your dryer are illustrated below. Become familiar with all parts and features before using your dryer.

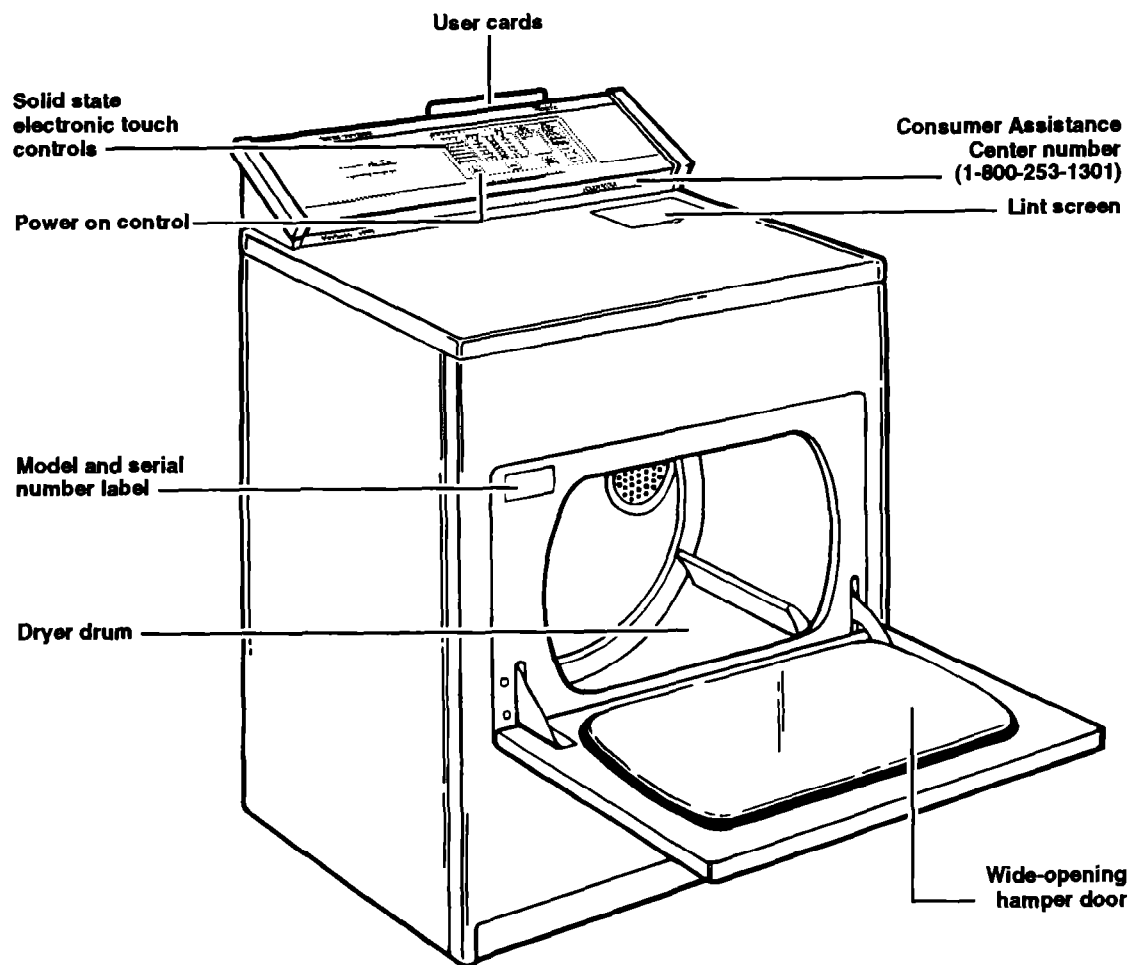

Other features not shown:

- Electronic DRY-MISER® control
- Drum light
- End-of-cycle signal selector
- FINISH GUARD® cycle selector
- Lint signal

User Cards

To help you quickly learn to use your machine, User Cards are located in the holder at the back of the control panel. (Refer to holder instructions if holder installation is required.) Each function on the control panel is briefly described on a User Card.

- Place the User Card for the desired function over the Electronic Touch Controls and make selections.

Operating Your Dryer

In This Section		Page	Page
Before starting your dryer	6	Using Automatic drying	8
Using the electronic touch controls	6	Using Timed drying	9
Starting your dryer	7	Selecting cycles/temps	10
Stopping and restarting your dryer.....	7		

Your new electronic dryer, with its solid state touch controls, offers you many electronic features and options that may be new to you. The following operating instructions and your User Cards will help you quickly learn to operate your new dryer.

Before starting your dryer

Place load in the dryer and close the door. Refer to the information below, and "Laundry Tips" on page 20 for control setting, sorting, and loading information.

NOTE: If your dryer has a Features Guide, remove it and place it in your Use and Care Guide.

Using the electronic touch controls

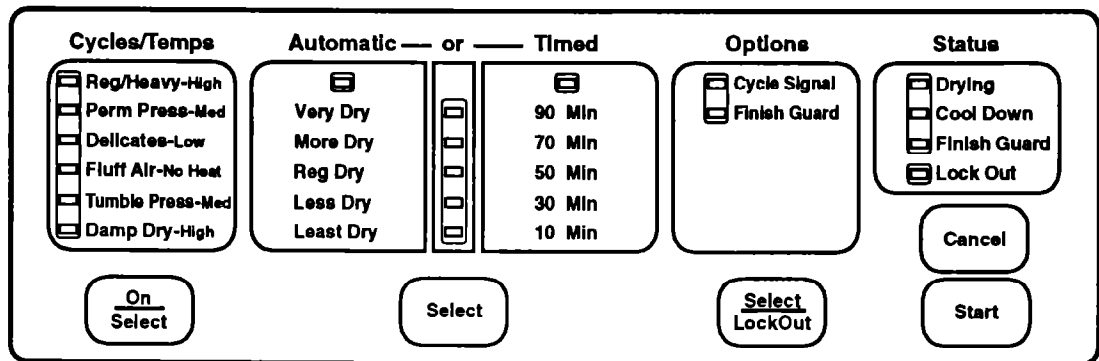

Audible tones guide your selections. You will hear:

- one tone if the dryer accepts your selection.
- three tones if the dryer does not accept your selection.

OPERATING YOUR DRYER

Starting your dryer

1. Press ON/SELECT

until the light glows by the cycle desired.
Refer to pages 8-14 for additional information to help you make selections.

PRESS



YOU SEE

Cycles/Temps

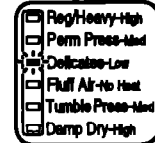

2. Press START.

PRESS



NOTE: Your dryer stops automatically when the cycle ends.

Stopping and restarting your dryer

- To stop your dryer at any time to add or remove clothes, open the door. Close door and press START.

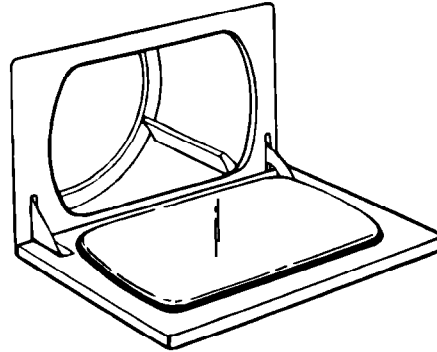

- To change the settings, press CANCEL and repeat Steps 1 and 2 above.

NOTE: When you press CANCEL, your dryer will stop.

PRESS



OPERATING YOUR DRYER

Using Automatic drying

Use Automatic drying to dry most loads. Your dryer automatically shuts off when the selected dryness is reached.

Reg Dry is the preset automatic dryness selected for Reg/Heavy-High, Perm Press-Med, and Delicates-Low cycles. You can change the Automatic setting (or select a Timed setting) to match your load.

1. Press ON/SELECT

until the light glows by the Cycle/Temp desired (Reg/Heavy, Perm Press, or Delicates).

PRESS



YOU SEE

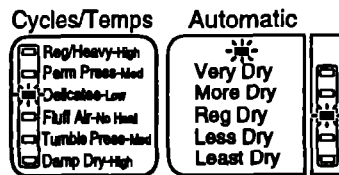

2. Press SELECT

until the light glows below "Automatic" and by the desired Automatic dryness. (Change Options, if desired. See pages 13-14.)

PRESS



YOU SEE

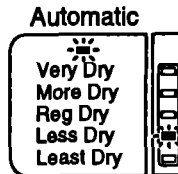

3. Press START.

PRESS



Use Automatic drying to dry most loads

If you want to dry a load using a Timed setting, see "Using Timed drying" on page 9.

- If the load is drier than you like, select LESS DRY or LEAST DRY the next time you dry a similar load.
- If the load is not as dry as you like, complete drying using a Timed setting. Select MORE DRY or VERY DRY the next time you dry a similar load.

NOTE: When you press Select, the Automatic dryness settings are selected first (starting with Reg Dry). Continue to press Select for a Timed setting (see page 9).

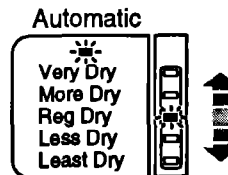

Using Timed drying

Use Timed drying to complete drying if some items are damp after Automatic drying. Timed drying is also useful to dry delicate items that require a short drying time.

1. Press ON/SELECT

until the light glows by the Cycle/Temp desired.

PRESS



YOU SEE

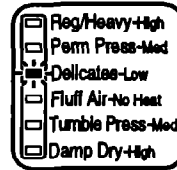

2. Press SELECT

until the light glows below "Timed" and by the desired drying time. (Change Options, if desired. See pages 13-14.)

NOTE: If you select the Reg/Heavy, Perm Press or Delicates cycle, an Automatic dryness is preset. If you desire Timed dryness instead, continue to press SELECT until the Timed light glows (Automatic light shuts off) and the light glows by the desired time. If you pass the desired time, continue to press SELECT until the light glows under Timed and by the desired time.

PRESS



YOU SEE

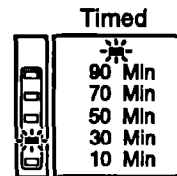

3. Press START.

PRESS



OPERATING YOUR DRYER

Selecting cycles/temps

Press ON/SELECT until the light glows by the desired cycle. (The “preset” selections are: Perm Press-Med, Automatic Reg Dry with Cycle Signal and FINISH GUARD® Options ON.)

YOU SEE

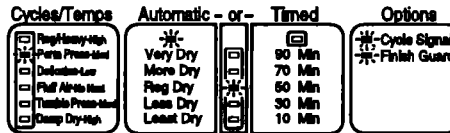

Preset selections

To select a different cycle/ temp

Press ON/SELECT until the light glows by the desired Cycle/Temp. Your dryer makes selections for each Cycle/Temp. You can change these selections if desired. See the charts on pages 11 and 12 for the selection you want to change.

PRESS



YOU SEE

Cycles/Temps

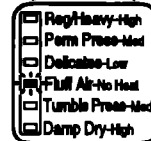

WARNING



Fire Hazard

Do not dry plastic or rubber items with heat. Use the Fluff Air cycle, or line dry. Failure to do so could result in fire or damaged items.

NOTES:



- The last few minutes of all cycles are without heat to make the load easier to handle.
- To help reduce wrinkling, remove the load from the dryer as soon as tumbling stops. This is important for permanent press, knits and synthetic fabrics.

Cycle chart

CYCLE/TEMP	USE FOR	CYCLE NOTES
<p>Reg/Heavy-High</p>  <p>Preset Selections</p> <ul style="list-style-type: none"> Reg Dry Cycle Signal Finish Guard 	<p>Cotton and Linens</p> <ul style="list-style-type: none"> • Extra Heavy or Heavyweight items; bedspreads, mattress pads, quilts, towels, jeans, corduroys, work clothes • Mediumweight items; sheets, cotton underwear, diapers 	<ul style="list-style-type: none"> • You may select a different Automatic dryness or use a Timed setting. Automatic drying will dry a load in less time than a Timed setting, and will be less likely to overdry.
<p>Perm Press-Med</p>  <p>Preset Selections</p> <ul style="list-style-type: none"> Reg Dry Cycle Signal Finish Guard 	<p>Cotton and Linens</p> <ul style="list-style-type: none"> • Lightweight; batistes, organdies, lingerie <p>Permanent Press, Synthetics, Blends</p> <ul style="list-style-type: none"> • Heavy or Mediumweight; work clothes, jackets, raincoats, shirts, play clothes, sheets, slacks <p>Knits</p> <ul style="list-style-type: none"> • Heavy or Mediumweight; cottons, rayons, blends, T-shirts, slacks, shirts, synthetics (polyester, acrylic, etc.) dress slacks, skirts, sweaters 	<ul style="list-style-type: none"> • Use the FINISH GUARD® option with this cycle to ensure the best wrinkle-free drying.
<p>Delicates-Low</p>  <p>Preset Selections</p> <ul style="list-style-type: none"> Reg Dry Cycle Signal Finish Guard 	<p>Knits</p> <ul style="list-style-type: none"> • Lightweight; synthetics (polyester, acrylic, etc.) and blends, lingerie, blouses, dresses <p>Delicate Fabrics</p> <ul style="list-style-type: none"> • Sheer curtains (2 or 3 panels), gauze, lace, etc. 	<ul style="list-style-type: none"> • When drying very delicate fabrics, use a Less Dry setting to remove some moisture. Then shape and line dry to complete drying.

continued on next page

OPERATING YOUR DRYER

CYCLE/TEMP	USE FOR	CYCLE NOTES
<p>Fluff Air-No Heat</p>  <p>Preset Selections</p> <ul style="list-style-type: none"> 50 Min Cycle Signal Finish Guard 	<p>Rubber, Plastic or Heat Sensitive Items</p> <ul style="list-style-type: none"> • Bedding, plastic tablecloths, foam rubber pillows, stuffed toys, sneakers, etc. 	<ul style="list-style-type: none"> • See Warning on page 10. • This cycle is unheated and uses a 50-minute Timed setting that you can change. Select a time to match the items you are fluffing or drying.
<p>Tumble Press-Med</p>  <p>Preset Selections</p> <ul style="list-style-type: none"> 30 Min Cycle Signal Finish Guard 	<ul style="list-style-type: none"> • Removing wrinkles from clothes that have been packed in a suitcase. • Removing wrinkles from items not removed from the dryer at the end of a cycle. 	<ul style="list-style-type: none"> • This cycle uses a fixed, 30-minute, Timed setting that cannot be changed. • As soon as the dryer stops, fold or put items on hangers.
<p>Damp Dry-High</p>  <p>Preset Selections</p> <ul style="list-style-type: none"> 30 Min Cycle Signal Finish Guard 	<ul style="list-style-type: none"> • Drying items to a damp level or to dry items that do not require an entire drying cycle. • Drying items you will press. • Drying heavy cottons, such as jeans, which you do not want to become stiff. 	<ul style="list-style-type: none"> • This cycle uses a fixed, 30-minute, Timed setting that cannot be changed.

Using Your Options/Features





In This Section	
	Page
Using Cycle Signal and FINISH GUARD® options	13
Understanding the FINISH GUARD cycle	14
Using the LockOut feature	14
Status lights	14

Your electronic dryer automatically selects the Cycle Signal and FINISH GUARD options. You may turn them off if you desire.

Using Cycle Signal and FINISH GUARD options

Cycle Signal and FINISH GUARD options are turned on when you press ON/SELECT. You can turn one or both options off if desired.

Option selection chart

Each time you press SELECT/LOCKOUT, you turn an option On or Off.		PRESS 	
First Press	Second Press	Third Press	Fourth Press
Options  Both options Off	Options  Cycle Signal On	Options  FINISH GUARD On	Options  Both options On

USING YOUR OPTIONS/FEATURES

Understanding the FINISH GUARD® cycle

When you are unable to remove a load from the dryer as soon as it stops, wrinkles can form. To protect the load, select the FINISH GUARD cycle.

- If you do not open the door within a few minutes after a cycle ends, the FINISH GUARD cycle protects your load.
- Your dryer tumbles the load (without heat) for a few seconds every few minutes. This tumbling rearranges and fluffs the load to help avoid wrinkles that set in when the load remains in the dryer.
- The FINISH GUARD cycle protects your load for about 150 minutes if the load remains in the dryer and the door is not opened.
- A signal will sound every few minutes during the FINISH GUARD cycle. The signal and the cycle will stop when the door is opened, or if you press CANCEL.

Options

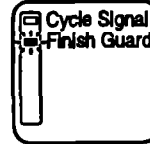

Using the LockOut feature

The LockOut feature allows you to “lock out” others from using your electronic controls. This feature is useful to lock the electronic controls, and to prevent the machine from being started, if you have young children.

To lock/unlock control panel

- Press and hold SELECT/LOCKOUT for 5 seconds.

The light glows by LockOut when the control panel is locked.

NOTE: You can only select LockOut when your dryer is **not** running and your control panel is off.

PRESS
AND HOLD



YOU SEE

Status



Status lights

Status lights show you what your dryer is doing. If the status lights are blinking, there has been a power failure. Press CANCEL. Make new selections, if desired.

Status



Caring For Your Dryer

In This Section		Page	Page
Maintenance-every load	15	Maintenance-as needed	16

Dryers require regular maintenance. Follow the suggestions below to maintain your dryer properly.

Maintenance-every load

Cleaning the lint screen

The lint screen is located under a lid on top of the dryer. **Clean it before each load.** A screen blocked by lint can increase drying time.

CAUTION

Product and Fabric Damage Hazard

Do not run the dryer with the lint screen loose, damaged, blocked or missing. Doing so could cause overheating and damage to both the dryer and fabrics.

1. Open the lid and pull the lint screen straight out.
2. Roll lint off the screen with your fingers. Do not rinse or wash the screen to remove lint. Wet lint is hard to remove.
3. Push the lint screen firmly back into place and close the lid.

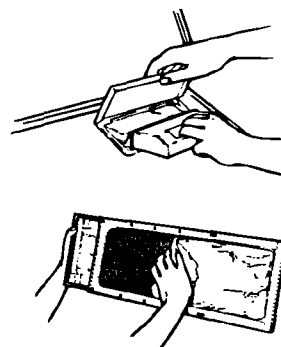

Lint signal

Restricted airflow reduces drying efficiency. The signal (a whistle tone) lets you know if the airflow is restricted.

- Turn off the dryer and clean the lint screen.

NOTE: Clean your lint screen before each load. Do not wait for the lint signal. The lint signal indicates excessive lint present on your lint screen. If you wait for the lint signal before you clean the lint screen, drying efficiency will be reduced.

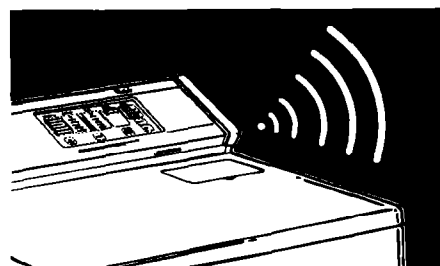

Maintenance-as needed

Use the following suggestions about cleaning and lint removal to maintain your dryer and keep it operating efficiently.

Cleaning a clogged lint screen

Laundry detergents and fabric softeners can cause a residue buildup on the lint screen. A clogged lint screen can extend drying times. Clean the lint screen every six months or more frequently if it becomes clogged due to a residue buildup. Use the following method:

1. Wet both sides of lint screen with hot water.
2. Wet a nylon brush with hot water and liquid detergent.
3. Scrub lint screen with the brush until all residue buildup is removed.
4. Rinse with hot water.
5. **Thoroughly** dry lint screen with a clean towel and replace in dryer.

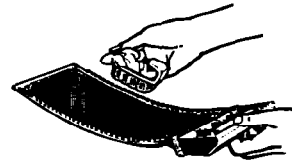

Cleaning the dryer interior

⚠ WARNING

Electrical Shock, Personal Injury and Fire Hazard

- Turn off the electrical power before cleaning the interior.
 - Make sure the dryer is cool.
 - Use nonflammable cleaner.
- Failure to do so could result in electrical shock or injury, fire or explosion.

Garments which contain unstable dyes, such as denim blue jeans or brightly colored cotton items, may discolor the dryer interior. If you want to remove stains from the dryer drum, use powdered laundry detergent.

1. Make a paste with detergent and very warm water.
2. Apply paste to a soft cloth and scrub area until all excess dye is removed.
3. Wipe thoroughly with a damp cloth.
4. Tumble a load of rags to dry.

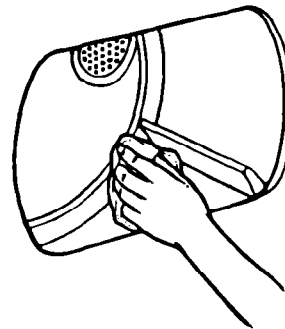

Cleaning the dryer exterior

Wipe with a soft, damp cloth.

Changing the drum light

⚠ WARNING

Electrical Shock and Fire Hazard

- Before removing light bulb, either unplug the dryer or disconnect the dryer at the main power supply.
- The bulb cover must be in place during dryer operation to prevent overheating and possible damage to fabrics. Operating the dryer with the bulb cover removed could cause the dryer to fail or create a fire hazard.

1. Unplug the dryer or disconnect the electricity leading to the dryer at the main power supply.
2. Open the dryer door and remove the light bulb cover from back wall of the dryer. Turn the cover clockwise to remove.
3. Remove the light bulb by turning it counterclockwise.
4. Replace the bulb with a 40-watt appliance bulb only.
5. Replace the light bulb cover and lock in place by turning counterclockwise.
6. Reconnect power supply.



Remove
bulb cover

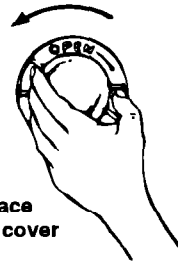

Replace
bulb cover

CARING FOR YOUR DRYER

Removing accumulated lint

Lint can gather inside the dryer and be a fuel for fire. It is recommended that lint be removed every 2 to 3 years, or more often, depending on dryer usage. Cleaning should be done by a qualified person. If you have any questions, please call our Consumer Assistance Center at 1-800-253-1301.

For all electric dryers, or gas dryers which have a lower front access panel

See page 19 if your dryer is gas and has a full front panel.

1. Unplug the power supply cord or turn off the electrical power.
2. Remove back panel (electric) or lower front access panel (gas). See the Installation Instructions.
3. Remove lint from shaded area in illustration with a soft brush or vacuum cleaner. Avoid damaging wires, thermostats (electric), funnel (gas) or ignitor (gas).
4. Replace panel; reconnect and level dryer again, if necessary.

⚠ WARNING

Electrical Shock and Personal Injury Hazard

- Unplug the power supply cord or turn off the electrical power before removing dryer panels.
- Make sure the dryer is cool.
- Dryer parts can have sharp edges. Use care when handling.
- When replacing front panel after lint removal, the wire clips holding the door switch wires must be anchored to top of front and side panels. Wires **MUST NOT** touch rotating drum. (See page 19, step 7.)

Failure to do so could result in electrical shock or personal injury.

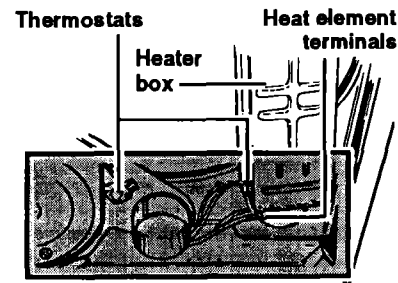

Electric dryer with back panel removed

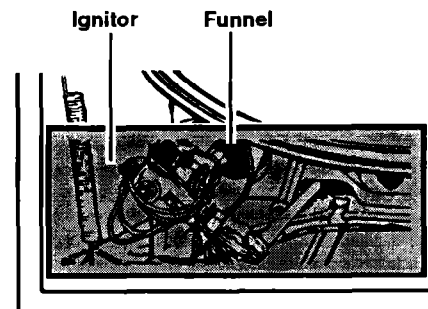

Gas dryer with front panel removed

CARING FOR YOUR DRYER

If your dryer is gas and has a full front panel, remove front panel as follows:

1. Unplug the power supply cord or turn off the electrical power.
2. Open lint screen lid. Remove two screws from lint screen area.
3. Open top by pulling forward and up at each front corner (see View A). Rest raised top against wall behind dryer (top is hinged at rear).
4. Remove two internal screws from front panel flanges (near top front corners). Lift front panel slightly, lifting off lower clips (see View B). Slowly pull front panel forward, disengaging panel from drum. (Drum will drop slightly.)
5. Move front panel aside and rest edge against side of dryer. Avoid disconnecting wire clips (see View C) or damaging wires.
6. Remove lint from area shown in "gas dryer" illustration on page 18 with soft brush or vacuum cleaner. Avoid damaging wires, funnel or ignitor.

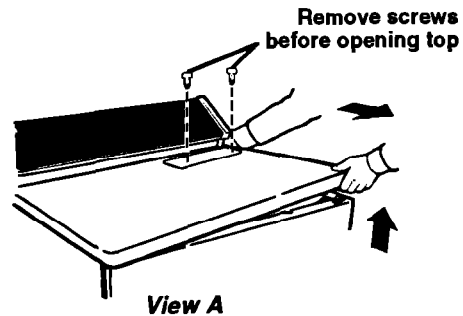

7. Reassemble in reverse order. Before closing the top, check the following:
 - Drum seal must be flared out (see View D) and properly positioned against panel at back of drum. Rotate drum counter-clockwise one full turn to check drum seal.
 - Belt should be centered and tight on dryer drum.
 - Wire clips which hold the door switch wires must be anchored in slot in top of front panel (see View C) and along top edge of side panel. Door wires must not touch drum when dryer is operating. See **Warning, page 18.**

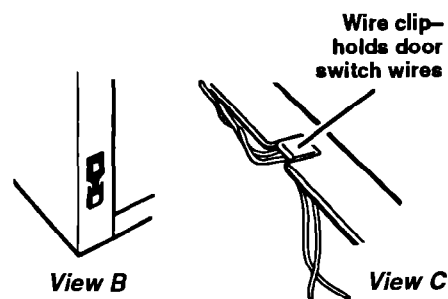
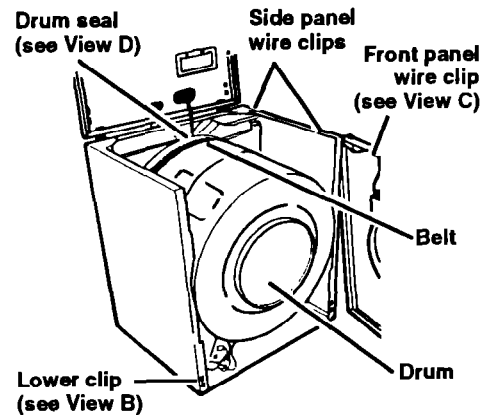

8. Replace top panel and lint screen screws. Top and front panels must be securely in place before operating dryer.
9. Reconnect power and level dryer again (if necessary).

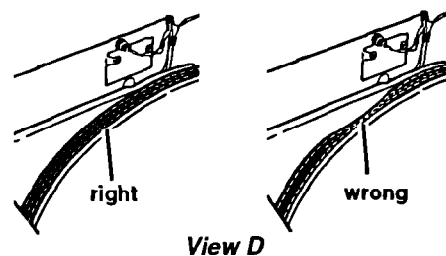

NOTE: Call our Consumer Assistance Center at 1-800-253-1301 for assistance or more information.

Laundry Tips

In This Section	
	Page
Before you dry	20
Drying special-care items	21
Using dryer fabric softeners	23
Saving energy	23
Vacation care	23
Solving laundering problems	24

This section reviews proper drying techniques, gives you additional drying information, and discusses causes or solutions to common drying problems.

Before you dry

Before using your dryer, see pages 3 and 4 for Important Safety Information.

Drying tips

- Close zippers, snaps and hooks to avoid snagging other items. Remove pins, buckles and other hard objects to avoid scratching the dryer drum. Remove heat-sensitive trim that can be damaged by drying.
- Check garments to make sure all spots and stains were removed during the wash. If stains were not removed, do not tumble dry. Heat may permanently set stain. Soiled items can also leave stains on the dryer drum. These stains can be picked up by other items in the load.
- Sharp or metal objects can damage your dryer. Check pockets for pins, clips, money, bolts, nuts, etc. and turn pockets inside out. Do not lay these objects on your dryer after emptying pockets.
- Tie strings and sashes so they will not tangle.
- Turn lint takers and dark items inside out to help prevent lint pickup.
- Place small items such as baby socks or hankies in a mesh bag for easier removal.
- Articles to be ironed should be removed from the dryer while still damp.



Sorting

- Separate dark from light colors; colorfast from noncolorfast. Items properly sorted for washing are usually properly sorted for drying. Separate heavy fabrics (denim, towels) from light fabrics (synthetics, permanent press).
- Separate lint givers (towels, chenille) from lint takers (corduroy, synthetics, permanent press). When possible, turn lint takers inside out.



Load sizes

- Mix large items with smaller items. Load the dryer by the amount of space items take up, not by their weight. Do not overload the dryer. Overcrowding causes uneven drying and wrinkling, and can cause items to wear out faster (because of pilling).
- You may need to rearrange large items (sheets, blankets, tablecloths) during a cycle to reduce balling or rolling up.
- Reduce wrinkling of permanent press and synthetics by drying smaller loads and removing items from the dryer as soon as tumbling stops.
- For better tumbling action when drying only a few small items, add one or two lint-free towels. This also prevents small, lightweight items from blocking airflow.



Drying special-care items

Most garments and household textiles have care labels with laundering instructions. Always follow label directions when they are available. General drying instructions for some special washables are included in this section.

<p>Air drying (heat-sensitive fabrics)</p> <ul style="list-style-type: none"> • Olefin, polypropylene, sheer nylon • Cotton and canvas shoes <p>Pillows, stuffed toys</p> <ul style="list-style-type: none"> • Feather, foam, polyester <p>Plastic, rubber items</p> <ul style="list-style-type: none"> • Shower curtains, tablecloths, baby panties <p>Scatter rugs</p>	<p>Heat-sensitive fabrics, plastic, rubber or some stuffed items require drying without heat. Use an Air setting or line dry. The Air setting is useful for fluffing bedding and pillows, and dusting draperies and clothing. See Warning on page 10.</p> <p>Follow care label directions.</p> <p>If shoes can be machine laundered:</p> <ol style="list-style-type: none"> 1. Place several bath towels in the dryer to act as a buffer, or place shoes on drying rack if your dryer has one. 2. If rubber or foam rubber materials are part of the shoe, use an Air setting. For other materials, see page 11 or 12 for cycle, time, and temperature recommendations. 3. Remove shoes from dryer while still damp and allow to air dry. <p>If manufacturer recommends machine drying, dry one pillow at a time and:</p> <ol style="list-style-type: none"> 1. Make sure coverings are securely stitched. 2. Shake and fluff the items by hand several times during the cycle. 3. Make sure pillows are completely dry. Feather pillows take a long time to dry. <p>Follow care label directions.</p> <p>Follow care label directions.</p>
<p>Blankets and woolens</p> <ul style="list-style-type: none"> • Cotton, rayon, synthetic blankets • Electric blankets, electric sheets, woolen blankets, washable woolen garments 	<p>Machine drying knitted woolens is not recommended. Block to shape while wet and allow to air dry. Line dry blankets in shade on a breezy day over two lines. Pin edges together and straighten them. When partly dry, turn the blanket over, re-pin and restraighten. When dry, brush nap.</p> <p>Dry as recommended for permanent press fabrics on page 11.</p> <p>If manufacturer recommends machine drying:</p> <ol style="list-style-type: none"> 1. Place one or two dry towels in the dryer and preheat 3-5 minutes on a high setting. This will dry blankets faster and help avoid pilling. 2. Put blanket in dryer with warm towels. Select 10 minutes Timed drying. 3. Check after 10 minutes. Remove when still damp. Overdrying and long tumbling can cause shrinking and pilling. 4. Place blanket on flat surface or over two lines to finish drying. Gently stretch to original size and shape. 5. When completely dry, brush gently to raise nap. Press binding with cool iron if needed.

continued on next page

LAUNDRY TIPS

<p>Curtains, slipcovers</p> <ul style="list-style-type: none"> • Draperies, slipcovers • Sheers, some synthetic curtains • Bonded or laminated fabrics 	<p>Remove drapery weights and hooks before laundering.</p> <ol style="list-style-type: none"> 1. Use Delicates-Low or Fluff Air-No Heat setting. 2. Leave room in dryer for load to fluff. 3. Remove from dryer while slightly damp. Do not overdry. <p>For slipcovers, replace slipcovers while still slightly damp. They will dry to fit tightly.</p> <p>Dry only a few minutes.</p> <p>Do not overdry or tumble in high heat. Overdrying loosens the adhesive and causes fabrics to separate.</p>
<p>Diapers, baby clothes</p>	<p>Wash and dry small items in a mesh bag or pillowcase for convenient handling.</p> <ol style="list-style-type: none"> 1. Dry according to fabric and cycle settings listed on page 11. 2. Remove diapers and cotton knit items while still slightly damp. They will feel softer, shrink less and be easier to fold.
<p>Elastic Items</p>	<p>Dry using Delicates-Low and Automatic Less Dry. Remove from dryer while still slightly damp.</p>
<p>Fiberglass materials</p>	<p>Do not machine wash or dry fiberglass materials. Small particles can stick to fabrics washed or dried in following loads and cause skin irritation.</p>
<p>Flame-retardant finishes</p>	<p>Some items have been treated with a flame-retardant finish to improve their resistance to burning. Such items are clearly labeled. To retain flame-retardant qualities through continuous use and washing, clean and dry according to the manufacturer's instructions.</p>
<p>Napped Items</p> <ul style="list-style-type: none"> • Corduroy, velveteen 	<p>Dry separately or with similar colors to avoid lint transfer. Follow care label directions.</p> <ol style="list-style-type: none"> 1. Dry according to fabric and cycle settings shown on page 11. 2. Remove from dryer while there is still a trace of moisture. 3. Smooth, reshape and air dry before putting away.
<p>Quilted, down-filled items</p>	<p>Follow care label instructions.</p> <ol style="list-style-type: none"> 1. Dry one at a time. 2. Remove from dryer and shake or fluff the item during the drying cycle. 3. Smooth and reshape before putting away.
<p>Snowsuits, jackets</p> <ul style="list-style-type: none"> • Nylon, polyester-base 	<p>Check label for fiber content, then see page 11 or 12 for cycle/temperature recommendations.</p> <p>Follow care label directions.</p> <ol style="list-style-type: none"> 1. Dry garment for about 10 minutes. Remove and turn inside out. Dry for 10 more minutes. 2. Remove from dryer immediately and hang on a non-rusting hanger to finish drying. This will help eliminate wrinkles.

Tinted, dyed or noncolorfast items	Dry according to fabric, weight and care label instructions. Wipe the dryer drum carefully to remove any dye or lint that can be transferred to other loads. See "Cleaning the dryer interior" on page 16.
Towels	Select cycle according to fabric type. Some towels, particularly those made of a blend of synthetic fibers and natural fibers (polyester and cotton blends), may shed more lint than other towels, causing your dryer's lint screen to get full faster. Be sure to remove lint from the dryer lint screen before and after drying new towels.
Washable knits	Do not overdry knits. Overdrying can cause shrinking and static cling. <ol style="list-style-type: none"> 1. Select cycle according to fabric and construction. 2. Turn synthetics and blends inside out when drying to avoid pilling. 3. Remove cotton and rayon knits while still slightly damp. Stretch into shape and lay flat to finish drying.

Using dryer fabric softeners

Dryer fabric softeners are recommended for reducing static cling (static can also be reduced by not overdrying) and for softening fabrics. Always follow package instructions carefully.

- Put fabric softener sheet on top of the load **before starting the dryer**. Do not add a fabric softener sheet **after** the cycle has started. Instant heat can cause the fabric softener to spot fabrics.

- Clear, grease-like spots can result from the fabric softener sheet becoming tangled in an item during tumbling. If fabric softener causes a stain, wet the stain and rub with liquid detergent or bar soap, rewash.
- Some fabric softeners can clog the lint screen and slow drying. Use fabric softeners labeled as dryer safe.

Saving energy

- Use Automatic drying for most loads.
- Dry only full loads without overdrying.
- Avoid overloading dryer, adding wet items to a partly dried load, or opening the door unnecessarily.
- Plan your laundry to dry one load after another. A warm dryer shortens drying time.
- Shorten drying times by exhausting dryer properly and cleaning exhaust duct and outside exhaust hood as needed.
 - Keep the lint screen clean.
 - Use your dryer in a room where room air temperature is above 45°F (7°C).
 - Sort loads by fabric weight and type.

Vacation care

1. Unplug power supply cord or turn off electrical power supply.
2. Clean lint screen.

LAUNDRY TIPS

Solving laundering problems

Most laundering problems are easily solved. Check the following list for problems you may have and possible causes. If you need additional help, check the "If You Need Assistance Or Service" section of this book.

PROBLEM	CHECK IF	CAUSES/SOLUTIONS
Greasy spots	<p>Dryer fabric softeners were used</p> <p>Undiluted washer fabric softener was used</p> <p>Enough detergent was used</p> <p>Items were clean before they were dried</p>	<p>Follow manufacturer's directions carefully.</p> <p>Dilute fabric softener before adding to the final rinse.</p> <p>Use enough detergent to hold soil in the wash water until it drains away. Undrained soil can stick to outer tub of the washer and cause greasy spots with next load.</p> <p>Soiled items can stain other items in the load. They can also leave stains on the dryer drum that can be picked up by items in later loads. Dryer heat may permanently set these stains.</p>
Lint	<p>Lint screen is clogged</p> <p>Load is properly sorted</p> <p>Static electricity is attracting lint</p> <p>Load is too big or heavy</p> <p>Paper or tissue was in pocket</p> <p>Enough detergent was used</p> <p>Pilling is being mistaken for lint</p>	<p>Clean lint screen. (See page 15.)</p> <p>Sort lint-givers (bath towels, etc.) from lint-takers (synthetics, permanent press).</p> <p>Use fabric softener in the washer's final rinse. Use correct dryer settings for fabric. Overdrying synthetics can cause lint-attracting static electricity.</p> <p>Dry smaller loads. When items can't tumble freely, air is unable to carry lint to lint screen.</p> <p>Empty pockets carefully. A small scrap of paper can cause a lot of lint.</p> <p>Use enough detergent to hold the lint in the water until it drains away. Base detergent amount on water hardness and soil in wash load.</p> <p>Pilling (surface fuzz) is caused by normal wear and laundering. Pills do not break away easily from the fabric and can often collect lint. Synthetic fabrics are more likely to pill than others, especially at neckbands, elbows and knees.</p>

LAUNDRY TIPS

PROBLEM	CHECK IF	CAUSES/SOLUTIONS
Shrinking	<p>Items are overdried</p> <p>Fabric type and quality is suitable for drying</p>	<p>Remove items while there is still a trace of moisture. Some items should be removed while damp, then shaped and air dried.</p> <p>Some knits are stretched during manufacturing. Washing and drying returns them to the original size. This is normal. Check quality of garment before buying. Follow fabric care label directions carefully.</p>
Slow drying	<p>There is a large amount of moisture in the load to be dried</p> <p>Cold rinse water is used</p> <p>Room air temperature is below 45°F (7°C)</p> <p>Dryer is exhausted according to Installation Instructions</p> <p>Lint screen is clogged</p> <p>Exhaust duct or outside exhaust hood is clogged</p> <p>Proper electrical supply is used</p>	<p>Some items hold more moisture than others (cottons more than polyester). They take longer to dry. Full loads take longer to dry than small loads of the same fabric.</p> <p>A load rinsed in cold water will take slightly longer to dry than a warm one. Cold rinses, however, help save energy and reduce wrinkling more than warm rinses do.</p> <p>Install dryer in a room where the air temperature is warmer than 45°F (7°C). Cold air increases drying time and may cause wrinkles not to be removed.</p> <p>Install and exhaust your dryer according to the Installation Instructions provided.</p> <p>Clean lint screen before or after each use.</p> <p>Clean if needed.</p> <p>Properly connect the dryer to a grounded electrical circuit that meets the electrical requirements stated in the Installation Instructions.</p>
Static electricity	<p>Load is overdried</p> <p>Fabric softener is used</p> <p>Synthetics, synthetic blends, permanent press and knits are in load</p>	<p>Remove items while there is still a trace of moisture.</p> <p>Use a fabric softener and follow package directions carefully.</p> <p>Synthetics, synthetic blends, permanent press and knits build up static electricity. Use a fabric softener and be careful not to overdry the load.</p>

IF YOU NEED ASSISTANCE OR SERVICE

If You Need Assistance Or Service

1. Before calling for assistance ...



Is the power cord plugged in?



Is lint screen clogged with lint?



Is exhaust duct or outside exhaust hood plugged with lint?



Have you blown a fuse or tripped the circuit breaker?

If you need more help, check the chart below.

PROBLEM	CHECK THE FOLLOWING
Dryer will not run	Is the dryer door firmly closed? Did you firmly push ON/SELECT and/or START?
Dryer will not heat	Is the cycle in the last few minutes? (There is no heat during that time.) If you have a gas dryer, are the valves open on both the dryer and the supply line?
Drying time too long	Is your lint screen clean? (See the "Slow drying" section of the table on page 25 for additional information.)

IF YOU NEED ASSISTANCE OR SERVICE

2. If you need assistance* ...

Call Whirlpool Consumer Assistance Center telephone number. Dial toll-free from anywhere in the U.S.A.:

1-800-253-1301

and talk with one of our trained consultants. The consultant can instruct you in how to obtain satisfactory operation from your appliance or, if service is necessary, recommend a qualified service company in your area.

If you prefer, write to:

Mr. William Clark
Consumer Assistance Representative
Whirlpool Corporation
2000 North M-63
Benton Harbor, MI 49022-2692

Please include a daytime phone number in your correspondence.

3. If you need service* ...

Whirlpool has a nationwide network of authorized Whirlpool service companies. Whirlpool® service technicians are trained to fulfill the product warranty and provide after-warranty service, anywhere in the United States. To locate the authorized Whirlpool service company in your area, call our Consumer Assistance Center telephone number (see Step 2) or look in your telephone directory Yellow Pages under:

• APPLIANCE-HOUSEHOLD-
MAJOR, SERVICE & REPAIR
- See: Whirlpool Appliances or
Authorized Whirlpool Service
(Example: XYZ Service Co.)

• WASHING MACHINES &
DRYERS, SERVICE & REPAIR
- See: Whirlpool Appliances or
Authorized Whirlpool Service
(Example: XYZ Service Co.)

* When asking for help or service:

Please provide a detailed description of the problem, your appliance's complete model and serial numbers and the purchase date. (See page 2.) This information will help us respond properly to your request.

4. If you need FSP® replacement parts ...

FSP is a registered trademark of Whirlpool Corporation for quality parts. Look for this symbol of quality whenever you need a replacement part for your Whirlpool® appliance. FSP replacement parts will fit right and work right, because they are made to the same exacting specifications used to build every new Whirlpool appliance.

To locate FSP replacement parts in your area, refer to Step 3 above or call the Whirlpool Consumer Assistance Center number in Step 2.

5. If you are not satisfied with how the problem was solved ...

- Contact the Major Appliance Consumer Action Panel (MACAP). MACAP is a group of independent consumer experts that voices consumer views at the highest levels of the major appliance industry.
- Contact MACAP only when the dealer, authorized servicer and Whirlpool have failed to resolve your problem.
Major Appliance Consumer Action Panel
20 North Wacker Drive
Chicago, IL 60606
- MACAP will in turn inform us of your action.

WHIRLPOOL® Dryer Warranty

LENGTH OF WARRANTY	WHIRLPOOL WILL PAY FOR
FULL ONE-YEAR WARRANTY From Date of Purchase	FSP® replacement parts and repair labor to correct defects in materials or workmanship. Service must be provided by an authorized Whirlpool service company.
LIMITED FIVE-YEAR WARRANTY From Date of Purchase	FSP replacement parts for the electronic control system if defective in materials or workmanship.
WHIRLPOOL WILL NOT PAY FOR	
<p>A. Service calls to:</p> <ol style="list-style-type: none"> 1. Correct the installation of your dryer. 2. Instruct you how to use your dryer. 3. Replace house fuses or correct house wiring or plumbing. 4. Replace light bulbs. <p>B. Repairs when your dryer is used in other than normal, single-family household use.</p> <p>C. Pickup and delivery. Your dryer is designed to be repaired in the home.</p> <p>D. Damage to your dryer caused by accident, misuse, fire, flood, acts of God or use of products not approved by Whirlpool.</p> <p>E. Any labor costs during the limited warranty.</p> <p>F. Repairs to parts or systems caused by unauthorized modifications made to the appliance.</p>	

6-94

WHIRLPOOL CORPORATION SHALL NOT BE LIABLE FOR INCIDENTAL OR CONSEQUENTIAL DAMAGES. Some states do not allow the exclusion or limitation of incidental or consequential damages, so this limitation or exclusion may not apply to you. This warranty gives you specific legal rights, and you may also have other rights which vary from state to state.

Outside the United States, a different warranty may apply. For details, please contact your authorized Whirlpool distributor or military exchange.

If you need service, first see the "If You Need Assistance Or Service" section of this book. After checking "If You Need Assistance Or Service," additional help can be found by calling our Consumer Assistance Center telephone number, **1-800-253-1301**, from anywhere in the U.S.A.



Printed on recycled paper—
10% post-consumer waste
50% recovered materials

PART NO. 3396304

© 1994 Whirlpool Corporation

® Registered Trademark of Whirlpool, U.S.A.

Printed in U.S.A.